

DECALS



Part No. 1700259. Located on Blower.

OPERATOR'S MANUAL

*MOWER DRIVEN
VACUUM COLLECTOR*

*BLOWER ASSEMBLY
48" MOWER
MFG. NO. 1691258*

*BLOWER ASSEMBLY
60" MOWER
MFG. NO. 1691259*

Table of Contents

DECALS

SAFETY RULES

INSTALLATION - BLOWER ASSEMBLY - 48" MOWERS

INSTALLATION - BLOWER ASSEMBLY - 60" MOWERS

INSTALLATION - DISCHARGE TUBE

OPERATION

OPERATING WITHOUT COLLECTION SYSTEM

Safety Rules



Read these safety rules and the safety rules in your Operator's Manual and follow them closely. Failure to obey these rules could result in loss of control of vehicle, severe personal injury to yourself, or damage to property or equipment. The triangle  in the text signifies important cautions or warnings which must be followed.



WARNING

Do not operate the tractor unless the entire grass catcher system or mower discharge deflector is properly installed.



WARNING

Do not remove any parts of the grass catcher while the engine is running.



WARNING

Read and obey all safety warnings in your tractor Operator's Manual.



WARNING

Under normal use, the bag is subject to wear. Inspect the bag periodically for wear or weak spots, and if necessary, replace with an identical bag.



WARNING

Before raising cover, disengage mower, turn off engine and remove the key. Do not remove catcher tube from adapter or bag while mower is running.



WARNING

When operating on slopes, use front counterweight. Never operate on slopes greater than 30% (16.7°).

INSTALLATION - BLOWER ASSEMBLY - 48" MOWERS

NOTE

For easier access, the mower can be removed from the tractor. If mower is not removed, put in low cut position.

1. Remove the deflector (A, figure 1) by removing two carriage bolts (E, figure 1), lockwashers and nuts. Save fasteners for reinstallation.
2. Remove the rod (D, figure 1) and spring (B) from the deflector. These parts will not be used. The deflector will be reinstalled.
3. Remove the bracket (C, figure 1) from the mower deck. It will not be used.
4. Disconnect the pin at rear of left-hand bail arm so bail arm can be lifted. Then remove the left-hand belt cover by removing self-tapping screws. Discard the belt cover.
5. Slip the deck drive belt off of the left-hand arbor pulley. Remove the pulley by removing capscrew from top. Discard pulley and capscrew.
6. Install new arbor pulley, which has two pulley grooves. Use the new 7/16-14x2-1/4 capscrew and the existing flat washer and lockwasher. Torque to 50-70 ft.lbs.
7. Place the deck drive belt into lower groove of new pulley installed in step 6.

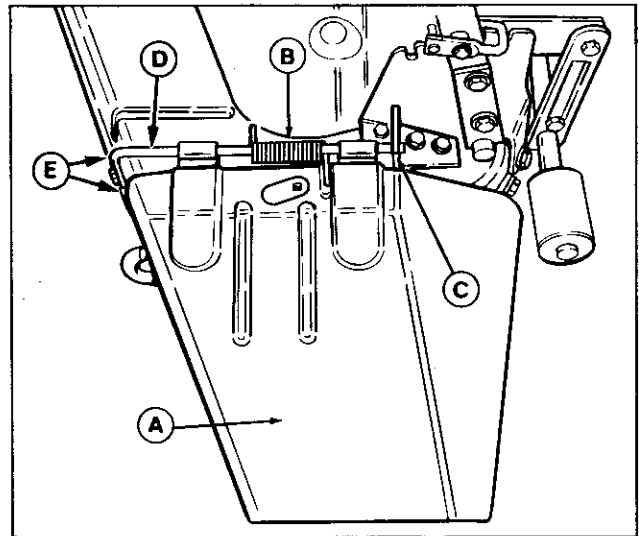

Figure 1. 48" Mower

- | | |
|--------------|--------------|
| A. Deflector | D. Hinge Rod |
| B. Spring | E. Bolts |
| C. Bracket | |

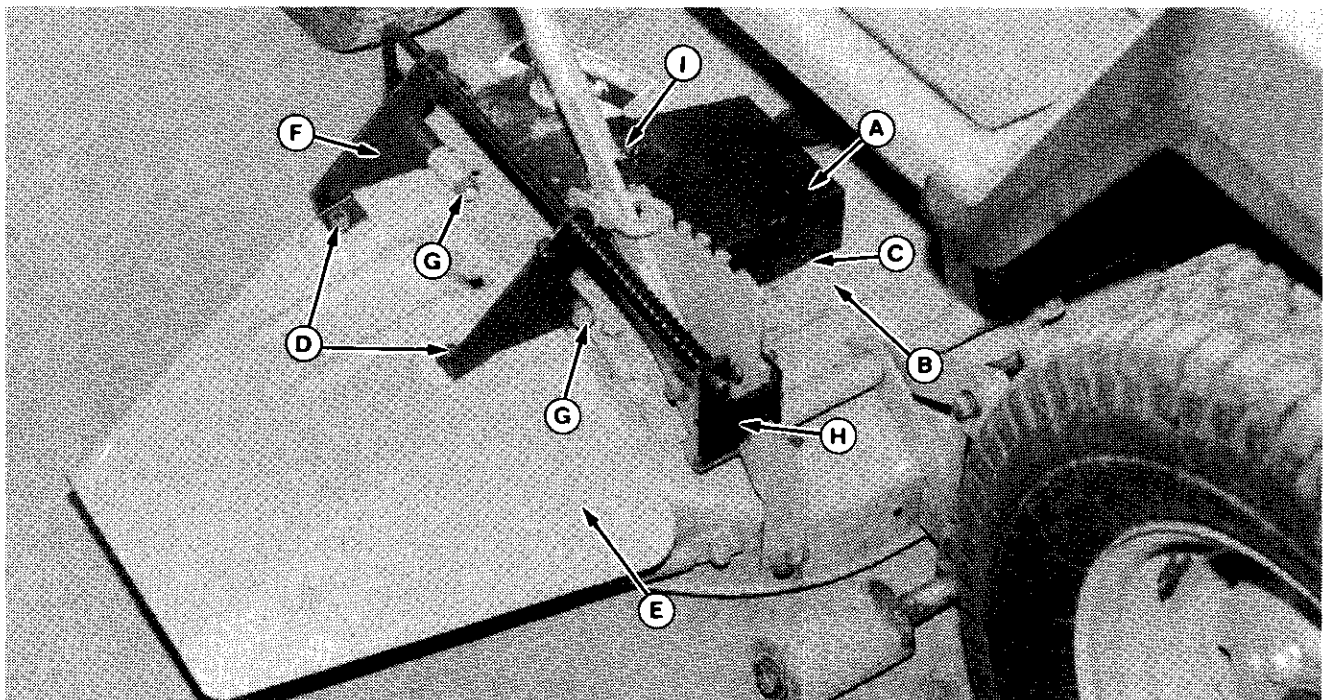

Figure 2.

- | | |
|-----------------|----------------------------|
| A. Pulley Cover | F. Bracket |
| B. Belt Cover | G. Capscrew, 7/16-14x2-1/4 |
| C. Nuts, #10-32 | H. Bracket |
| D. Nuts, 5/16 | I. Knob |
| E. Deflector | |

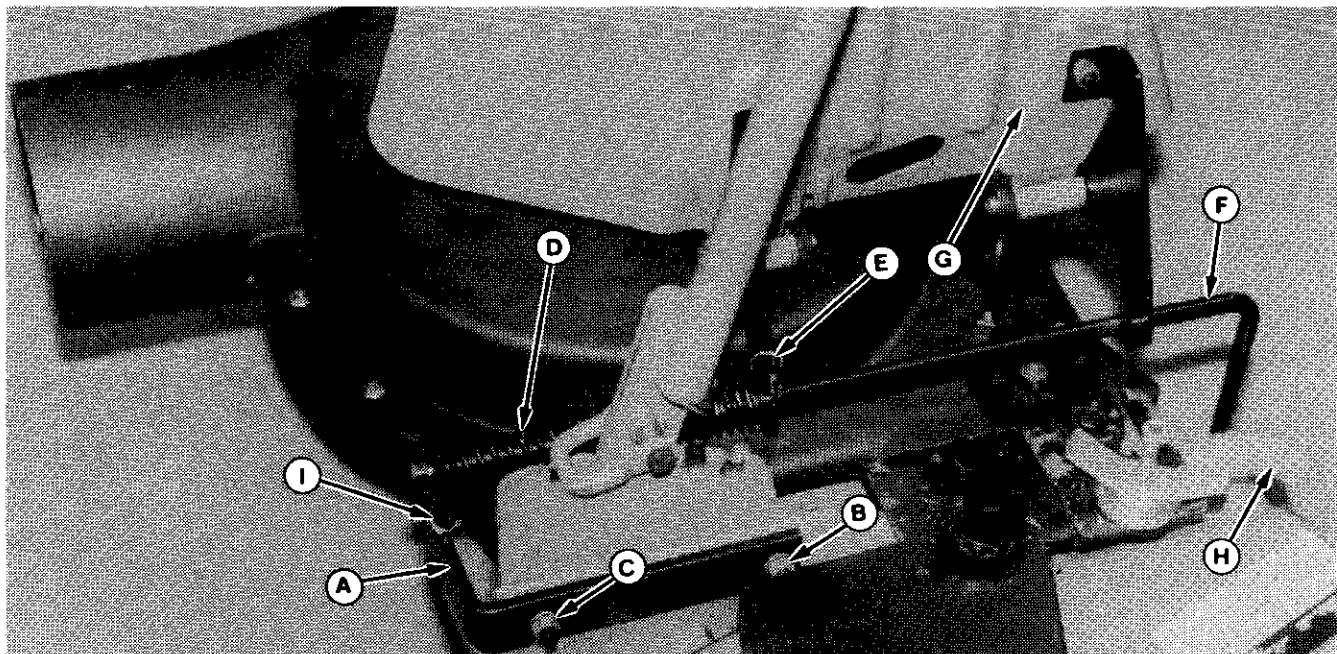

Figure 3.

- | | |
|----------------------------|--------------|
| A. Bracket | F. Rod |
| B. Capscrew, 5/16-18x1-1/4 | G. Deflector |
| C. Capscrew, 5/16-18x1-1/4 | H. Brace |
| D. Spring | I. Hook |
| E. Hook | |

8. Assemble the pulley cover (A, figure 2) to the new belt cover. (Pulley cover is Item A in figure 4; note position over arbor pulley). Use two #10-32x3/8 machine screws and two #10-32 nut-washer assemblies. The screws must be inserted from inside the belt cover, so that nuts (C, figure 2) are outside.
9. Install the new belt cover (B, figure 2) using the existing self-tapping screws.
10. Connect the rear end of bail arm with pin that was removed in step 4.
11. The two holes in deflector (D, figure 2) must be drilled out. Turn deflector over, and notice that these two holes are started. Drill two 11/32-inch holes.
12. Connect the deflector (E, figure 2) to the bracket (F) with two 5/16-18x7/8 screws, 5/16 lockwashers, and 5/16 nuts (D).
13. Install two 7/16-14x2-1/4 cap screws (G, figure 2), 7/16 lockwashers and 7/16 nuts, connecting deflector to bracket.
14. Connect bracket (H, figure 2) to the quadrant as follows. Remove the existing hardware (B & C, figure 3) at two places which hold the quadrant to the brace (H). Then connect the bracket (A) at front location (B) with new socket head 5/16-18x1-1/4 screw, and existing lockwasher and nut. At rear location (C) use new 5/16-18x1-1/4 cap screw and existing lockwasher and nut.

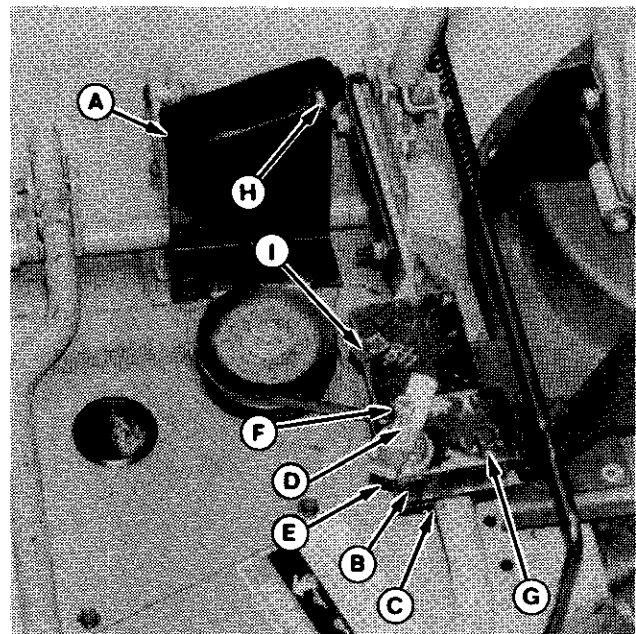

Figure 4.

- | | |
|----------------------------|--------------------------|
| A. Pulley Cover | F. Locknut, 5/16 |
| B. Clamp, Upper | G. Capscrew, 5/16-18x5/8 |
| C. Clamp, Lower | H. Knob |
| D. Capscrew, 5/16-18x2-1/2 | I. Clip |
| E. Wing Nut | |

15. Install lower and upper clamps (B, figure 4) as follows.

a. Position lower clamp (C) with groove on the quadrant support. Place upper clamp on top and assemble hardware. From bottom, insert a 5/16-18x2-1/2 capscrew (D, figure 4) and install a 5/16 lockwasher and 5/16 nut to secure in place. Then, install the wing nut (E) and 5/16 locknut (F). Tighten snug only.

b. Install 5/16-18x5/8 capscrew (G, figure 4), 5/16 lockwasher and 5/16 nut snug only.

c. Position the clamps on the quadrant support rod so that when the pulley cover (A, figure 4) closes, the knob (H) can be threaded into the clip (I). Keep clamps parallel to top surface of deck.

d. Tighten the hardware on both sides of clamp securely. The locknut (F) stays at top of capscrew (flush with end of capscrew).

16. Install the bracket (A, figure 5) and upstop (B). For the upstop, use one 1/4-20x7/8 capscrew (E) and one 1/4-20x5/8 capscrew (F) and 1/4 locknuts. Note that one screw also goes through bracket (A). For the bracket (A) use two 1/4-20x5/8 trusshead screws and 1/4 locknuts. Notice in the bracket (A) that holes are stamped 42" and 48". Use appropriate holes for mower.

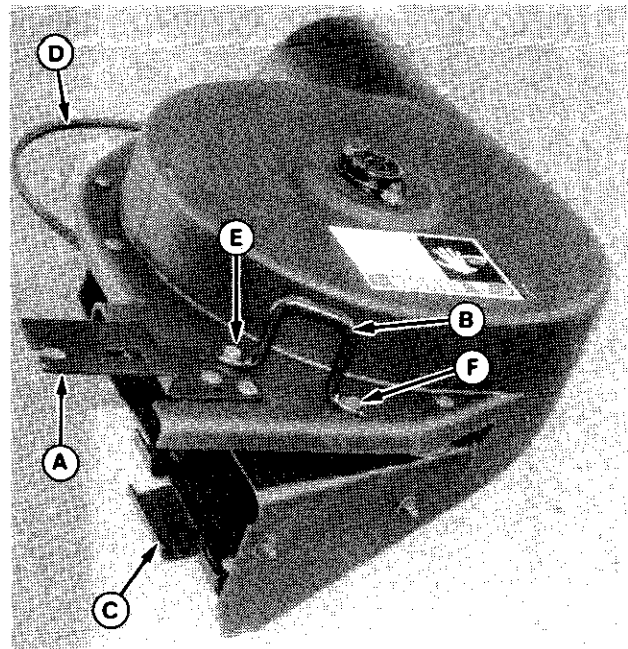

Figure 5.

- | | |
|---------------------|-------------------------|
| A. Bracket | D. Belt |
| B. Upstop | E. Capscrew, 1/4-20x7/8 |
| C. Stone Guard Hook | F. Capscrew, 1/4-20x5/8 |

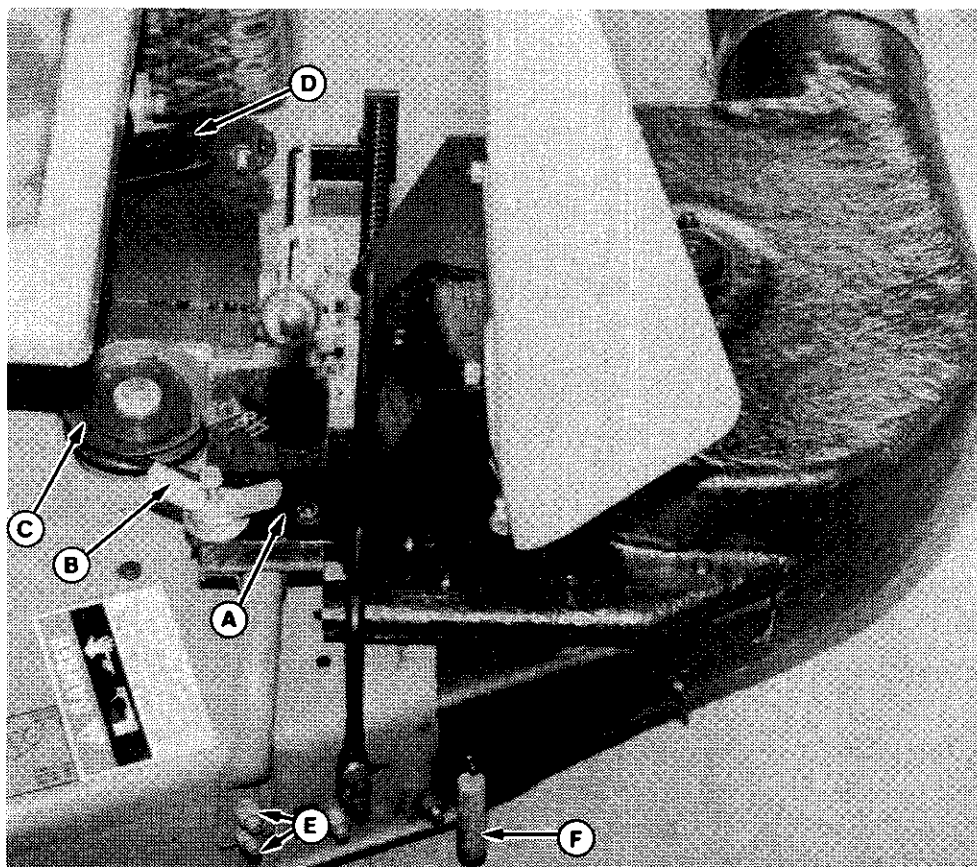

Figure 6.

- | | |
|-------------|----------------|
| A. Bracket | D. Cover |
| B. Wing Nut | E. Hardware |
| C. Pulley | F. Stone Guard |

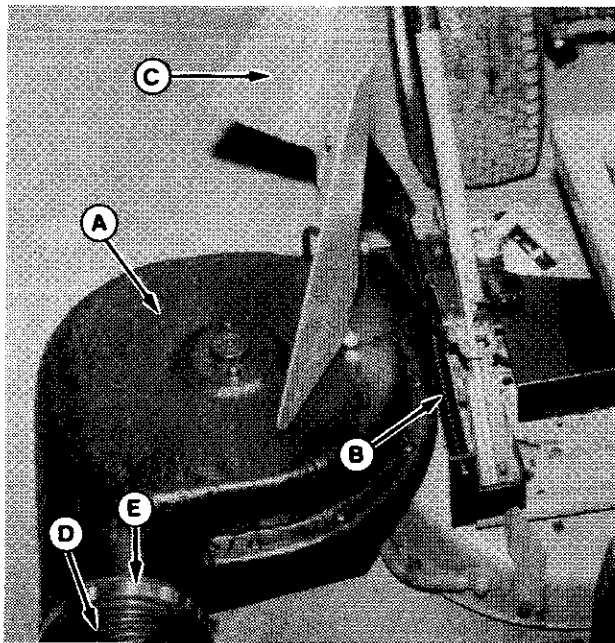

Figure 7.

- | | |
|--------------|----------|
| A. Blower | D. Tube |
| B. Spring | E. Clamp |
| C. Deflector | |

17. Check the belt (D, figure 5) routing in the blower. Make sure it is seated in all pulley grooves.
18. Install blower assembly onto mower as follows. When positioning the blower, be aware of belt position, which will be installed onto the pulley (C, figure 6).
 - a. Position the wing nut (B, figure 6) at top of screw.
 - b. Position bracket (A, figure 6) under wing nut (B) and tighten securely. Place stone guard hook (C, figure 5) under stone guard (F, figure 6).
 - c. Feed the belt into the pulley (C, figure 6) groove. Push the spring loaded idler pulley to provide slack in the belt.
 - d. Close the cover (D, figure 6) and tighten the knob into the clip (I, figure 4).
19. Install the deflector (G, figure 3) as follows. Insert the hinge rod (F) through the brackets and spring (D). Hook one end (E) onto deflector bracket. Place the deflector onto the mower and hook the other end of spring (I) onto bracket (A). Connect front of hinge rod to deck using original hardware (E, figure 6). Blower and deflector are also shown installed in figure 7.
20. Go to "Installation - Discharge Tube" on page 10.

INSTALLATION - BLOWER ASSEMBLY - 60" MOWERS

NOTE

For easier access, the mower can be removed from the tractor. If mower is not removed, put in low cut position.

1. Remove the deflector (A, figure 8) by removing carriage bolt (E, figure 8), lockwasher and nut. Save fasteners for re-installation.
2. Remove the rod (D, figure 8), spring (B), and clamp (F) from the deflector. These parts will not be used. The deflector will be reinstalled.
3. Remove the two brackets (C, figure 8) from mower deck by removing 3/8-16x7/8 carriage bolt, lockwasher and nut. Save fasteners for re-installation.
4. Disconnect the pin at rear of left-hand bail arm so bail arm can be lifted.
5. Remove the left-hand belt cover by removing self-tapping screws. Discard the belt cover.
6. Slip the deck drive belt off of the left-hand idler or arbor pulley.
7. Install the new left-hand idler pulley assembly as follows:
 - a. Remove the existing idler pulley. Discard hardware. Note which hole the idler pulley was installed in deck. The new pulley should be installed in same hole. (Note that the two mounting holes are 5/8" apart. The outer hole is used to mount idler pulley after drive belt is stretched.)

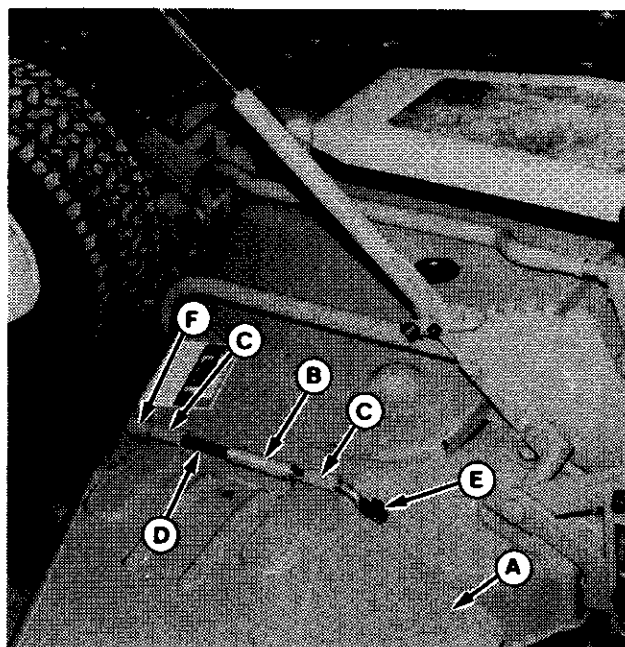

Figure 8.

- | | |
|--------------|--------------|
| A. Deflector | D. Hinge Rod |
| B. Spring | E. Bolt |
| C. Brackets | F. Clamp |

b. Remove the lockwasher and nut from bottom of idler pulley assembly, place assembly (A, figure 9) onto deck, and install lockwasher and nut from bottom of deck to secure in place. Be sure idler pulley rotates freely.

c. In the blower, the fixed, flat idler pulley (A, figure 10) may need to be moved in the slot it is mounted in. If the mower idler pulley (A, figure 9) is mounted in the outer hole in the deck, then the blower idler pulley (A, figure 10) should be as far toward the front as the slot will allow. If mower idler pulley (A, figure 9) is mounted in the inner hole, then the blower idler pulley (A, figure 9) should remain as installed at factory. To adjust, loosen pulley hardware, move idler pulley in slot, and then tighten.

8. Place the deck drive belt into lower groove of new pulley installed in step 7.
9. Assemble the pulley cover (B, figure 9) to the new belt cover. Use two #10-32x3/8 machine screws and two #10-32 nut-washer assemblies. The screws must be inserted from inside the belt cover, so that nuts (C, figure 11) are outside.
10. Install the bracket (C, figure 9) with two 1/4-20x3/4 capscrews, 1/4 lockwashers and 1/4 nuts. Install screws from bottom.
11. Be sure a 5/16 palnut (D, figure 9) is in place. When the pulley cover is closed, the knob (E) will thread into palnut (D).
12. Install the new belt cover (B, figure 11) using the existing self-tapping screws. Be sure belt cover does not contact pulley (A, figure 9).
13. Connect the rear end of bail arm with pin that was removed in step 4.
14. The two holes (A, figure 12) in deflector must be drilled out. Turn deflector over, and notice that these two holes are started. Drill two 11/32-inch holes.
15. Connect the deflector (B, figure 12) to the brackets (C) with two 5/16-18x7/8 screws, 5/16 lockwashers, and 5/16 nuts (A).
16. Install two 7/16 - 14x2-1/4 capscrews (D, figure 12), 7/16 lockwashers and 7/16 nuts, connecting deflector to bracket.
17. Two holes must be drilled in the mower deck for installation of the brackets (E, figure 12 and G, figure 11): one hole (G, figure 12) at the front; and one hole (D, figure 11) at the rear. To mark holes for drilling, install the two brackets using the two 3/8-16x7/8 carriage bolts, lockwashers and nuts which were removed in step 3. Install the rod (E, figure 13) to align the brackets. Mark holes (item D, figure 11 and item G, figure 12). Drill 13/32" holes.
18. In the new drilled holes, install two 3/8-16x7/8 capscrews, lockashers and nuts (G, figure 12 and D, figure 11).

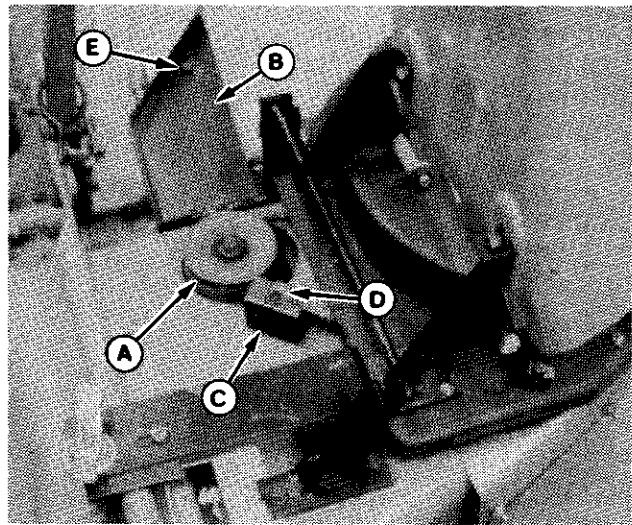

Figure 9.

- | | |
|--------------------------|-----------------|
| A. Idler Pulley Assembly | D. Palnut, 5/16 |
| B. Pulley Cover | E. Knob |
| C. Bracket | |

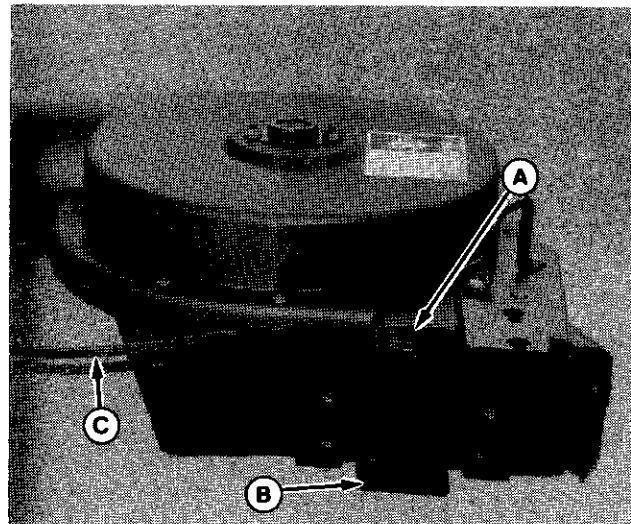

Figure 10.

- | |
|-----------------------|
| A. Fixed Idler Pulley |
| B. Stone Guard Hook |
| C. Belt |

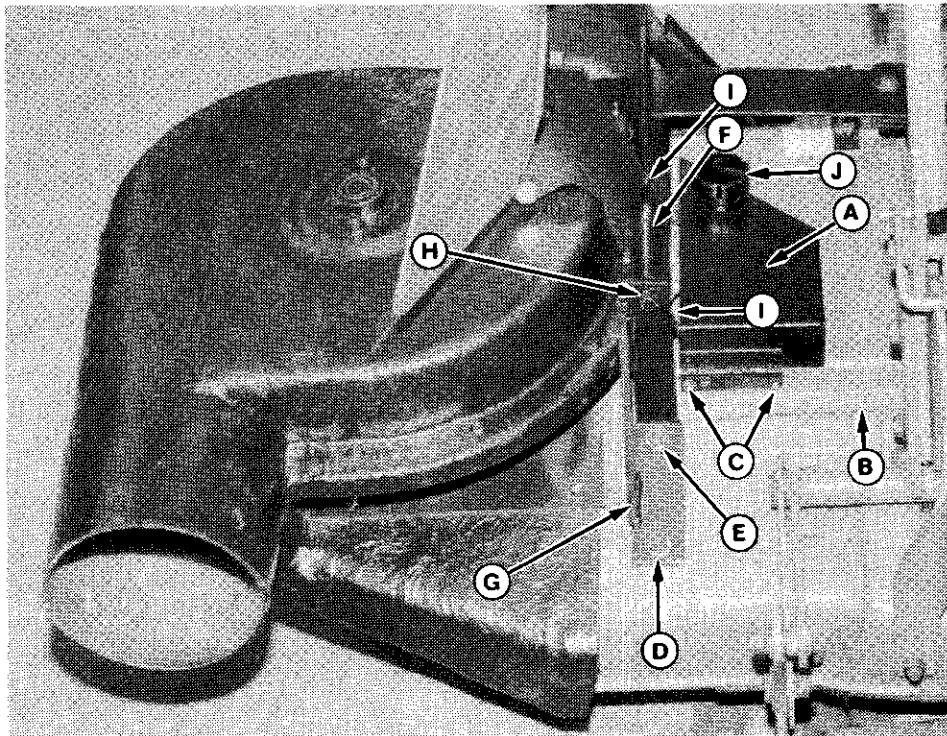

Figure 11.

- | | |
|-----------------|----------------|
| A. Pulley Cover | F. Spring |
| B. Belt Cover | G. Bracket |
| C. Nuts, #10-32 | H. Cotterpin |
| D. Drill Hole | I. Spring Hook |
| E. Nut, 3/8 | J. Knob |

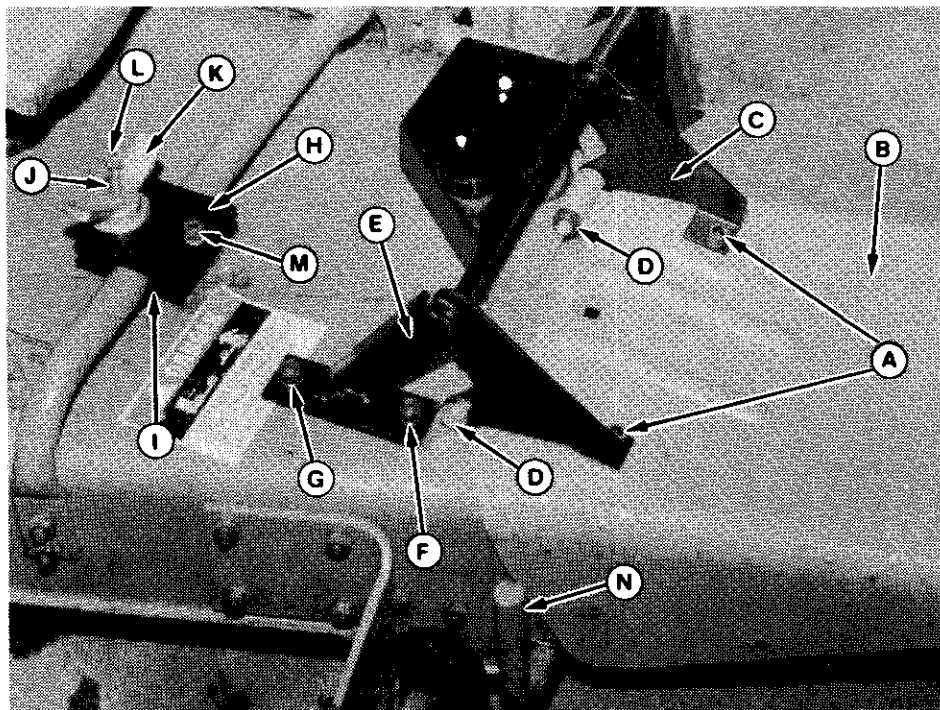

Figure 12.

- | | |
|-----------------------------|-----------------|
| A. Nuts, 5/16 | H. Clamp, Upper |
| B. Deflector | I. Clamp, Lower |
| C. Bracket | J. Cap screw |
| D. Cap screw, 7/16-14x2-1/4 | K. Wing Nut |
| E. Bracket | L. Locknut |
| F. Nuts, 3/8 | M. Nut |
| G. Drill Hole | N. Stone Guard |

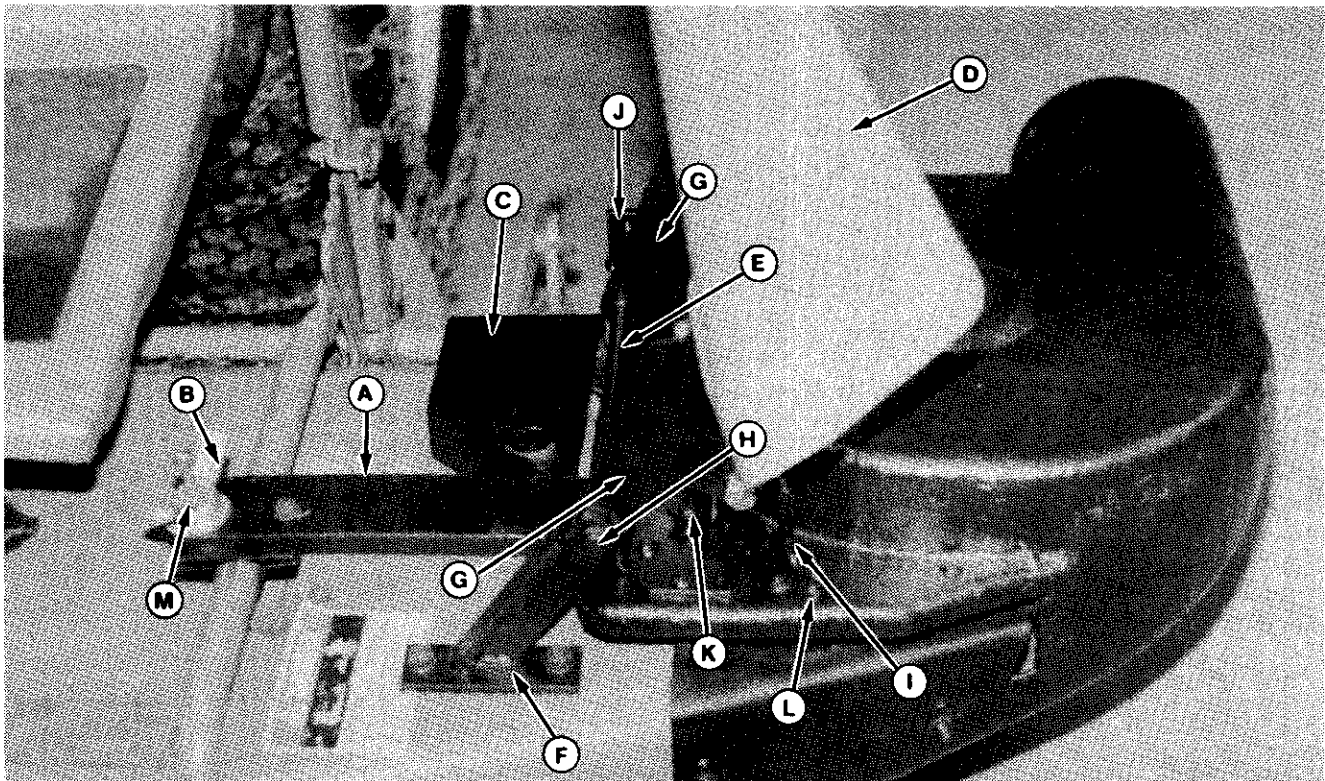

Figure 13.

- | | | |
|--------------|----------------------|-------------------------|
| A. Bracket | F. Bracket | K. Capscrew, 1/4-20x7/8 |
| B. Wing Nut | G. Deflector Bracket | L. Capscrew, 1/4-20x5/8 |
| C. Cover | H. Cotterpin | M. Screw |
| D. Deflector | I. Upstop | |
| E. Rod | J. Bracket | |

19. Install upper and lower clamps (H & I, figure 12) as follows:

- a. Position lower clamp (I) with groove on the quadrant support. Place upper clamp on top and assemble hardware. From bottom, insert a 5/16-17 x 2-1/2 cpscrew (J, figure 12) and install a 5/16 lockwasher and 5/16 nut to secure in place. Then install the wing nut (K) and 5/16 locknut (L) (tighten snug only).
- b. Install 5/16-18 x 5/8 capscrew (M) from underneath clamp. Secure with 5/16 lockwasher and nut.

20. Install the bracket (A, figure 13) and upstop (I) as follows:

- b. Install bracket with two 1/4-20 x 3/4 trusshead screws and 1/4 locknuts. Refer to figure 14 for correct capscrew location for mower size.

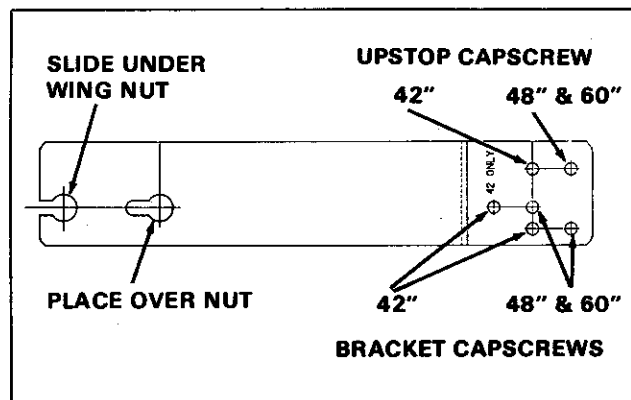

Figure 14. (Typical Bracket Shown)

CAUTION
 If deflector (D) contacts blower housing before upstop (I), use washers (as shims) under upstop to increase clearance. Damage to blower housing may occur unless deflector rests on upstop.

- a. Install upstop (I) with one 1/4-20 x 7/8 capscrew (K), 1/4-20 x 5/8 capscrew (L) and 1/4 locknuts. Note that capscrew (K) goes through bracket. Refer to figure 14 for correct location for mower size.

21. Check the belt (C, figure 10) routing in the blower. Make sure it is seated in all pulley grooves.
22. Install blower assembly onto mower as follows. When positioning the blower, be aware of belt position, which will be installed onto the pulley (A, figure 9).
 - a. Position the wing nut (B, figure 13) to the top of screw (M).
 - b. Position bracket under wing nut (B) and tighten securely. Place stone guard hook (B, figure 10) under the stone guard (N, figure 12).

- c. Feed the belt into the pulley (A, figure 9) groove. Push spring loaded idler to provide slack in belt.
 - d. Close the cover (C, figure 13) and tighten the knob into the palnut.
23. Install the deflector (D, figure 13) assembly as follows:
- a. Insert the rod (E) through the bracket (F), the deflector brackets (G and J) and spring (F, figure 11). Secure with cotterpin (H) on each end.
 - b. Hook the spring at two places (I, figure 11).
24. Go to "Installation - Discharge Tube" on page 10.

Installation - Discharge Tube

1. Attach the hose (A, figure 15) to the tube (B) by installing four #10-32x1/2 trusshead screws from inside, and then installing four #10 washers and locknuts (c) on the outside.
2. Insert the tube (B) fully into connecting sleeve in the cart. (Installation of sleeve is covered in the manual supplied with wide body cart collector.)
3. Attach the hose (A) to the blower (D) with clamp (E) and tighten clamp securely.

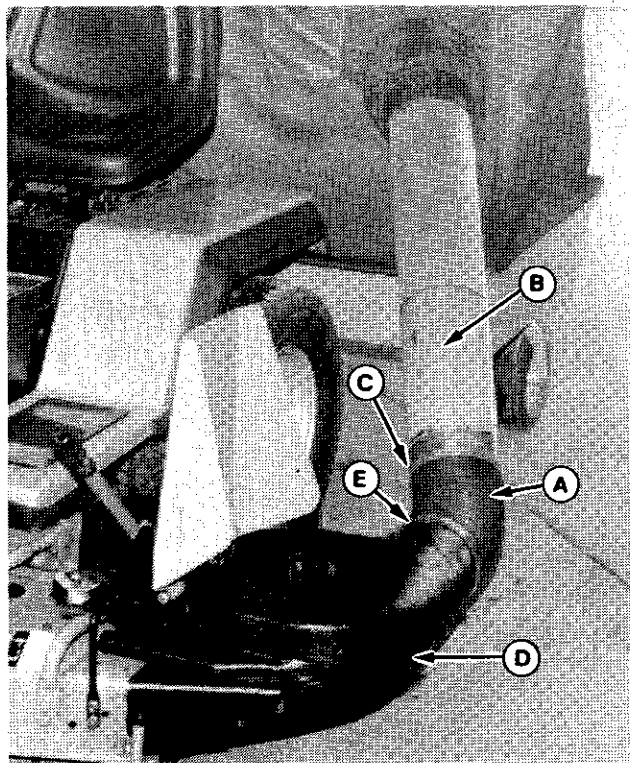

Figure 15.

- | | |
|------------|-----------|
| A. Hose | D. Blower |
| B. Tube | E. Clamp |
| C. Locknut | |

Operation

To install the collection system, refer to the manual supplied with the collection system. Operation information is included in that manual also.

OPERATING WITHOUT COLLECTION SYSTEM — 48" MOWERS



WARNING

The deflector is spring loaded. It will be necessary to hold the deflector up while removing the blower. Then, allow deflector to rotate down into original position.

1. Remove the belt from the pulley (C, figure 6) and close the cover (D).
2. Loosen the wing nut (B, figure 6) while holding the deflector up and remove the blower from the mower.
3. Allow the deflector to rotate down. It will appear as in figure 2.

OPERATING WITHOUT COLLECTION SYSTEM — 60" MOWERS



WARNING

The deflector is spring loaded. It will be necessary to hold the deflector up while removing the blower. Then, allow deflector to rotate down into original position.

1. Remove the belt from the pulley (A, figure 9) and close the cover (B).
2. Loosen the wing nut (K, figure 12) while holding the deflector up and remove the blower from the mower.
3. Allow the deflector to rotate down. It will appear as in figure 12.

